

SPECIFICATION		
DSP		
MODEL:	DSP 6KQ DSP10KQ	
Input:	4 channel	
Output:	4 channel	
PC Com Port:	1 USB Com Port on front panel, 1 USB Com Port, 2 RS485 Com Port on back panel (RJ-45)	
Processor:	48KHz Sampling frequency, 48-bit Fixed-Point DSP, 24-bit A/D and D/A converter	
Dynamic range:	>110dB	
Frequency Response:	±0.25dB, 20Hz--20KHz	
Distortion:	< 0.01%, 20Hz-20KHz @ +10dBu balanced input	
Signal to noise ratio:	>110dB	
crossover filter:	Each output channel can be independently set as LPF and HPF, The parameters can be adjusted, Filter type: Butterworth, Bessel, Linkwitz-Riley, The Crossover Frequency: 20Hz--20KHz, Slope: 12, 18, 24 or 48 dB/octave	
EQ:	Bandwidth: 0.2 to 36 oct, Frequency: 20Hz to 20KHz, Gain: -24dB to +12dB, step: 0.2 dB	
Delay:	0ms to 115ms	
Display:	2 x 20 LCD	
Store Settings:	20 user program dynamic storage	
AMPLIFIER		
Model	DSP 6KQ	DSP 10KQ
Output Power		
8 Ω Stereo Power	4×625W	4×1300W
4 Ω Stereo Power	4×1250W	4×2200W
2 Ω Stereo Power	4×1500W	4×2500W
8 Ω Bridged Monon Power	2×2500W	2×4400W
4 Ω Bridged Monon Power	2×3000W	2×5000W
Frequency Response	20Hz-20kHz ±0.5dB	
THD+N(Rated power, 4Ω/KHz)%	0.10%	
Signal Noise Ration(dB)	110dB	
Input Impedance	20KΩ Balanced / 10KΩ Unbalanced	
Output Connectors	Speakon Connectors(NEUTRIK)	
Power Requirement	100-120V-50-60Hz or 200-240V-50-60Hz	
Dimension		
Airframe	483×377×88mm	
Weight		
Weight(net)	13Kg	

Contents. 1

Important note. 2

Control elements. 3

Rear panel features introduction. 4

Rear panel features introduction. 5

Audio input and output connections. 6

PC Interface. 7

Professional Power Amplifier Specifications. 8

Important Note

WARNING NOTICES

SAFEGUARDS

Electrical energy can perform many useful functions, This unit has been engineered and manufactured to assure your personal safety. Improper use can result in potential electrical shock or fire hazards. In order not to defeat the safeguards, observe the following precautions for its installation, use and servicing.

Explanation of Graphical Symbols



**CAUTION
RISK OF ELECTRIC SHOCK
DO NOT OPEN**



**CAUTION
RISK OF ELECTRIC SHOCK :
OPEN ONLY IF QUALIFIED
AS SERVICE PERSONNEL**

WARNING: TO PREVENT FIRE OR ELECTRIC SHOCK, DO NOT EXPOSE THIS EQUIPMENT TO RAIN OR MOISTURE

IMPORTANT NOTE

ATTENTION: This unit must be protected from damp because of the risk of fire and the possibility of electric shocks.

1. Make sure that you have the correct mains voltage. Only operate the unit at the mains voltage marked on the rear panel.
2. Make sure that nothing especially no metal objects are inserted into the device. This could result in electric shock or malfunction.
3. If the unit is subjected to extreme fluctuations of temperature e.g. On being transported from outside into a heated room, condensation can form. This unit should not be used until it has reached room temperature.
4. In the event of water or any other fluid being accidentally spilt on the unit switch the unit off immediately and send it to a qualified service workshop for inspection.
5. Make sure that the unit is always well ventilated and never exposed to direct sunlight
6. Do not use sprays to clean the unit as they have a detrimental effect on the unit and could ignite suddenly.
7. The machine use single power switch, please cut off the power before fix.
8. Please do not put the cup, vessel of flower or container above the machine, in case the leak out water then cause the leakage current off the machine.

PC Interface

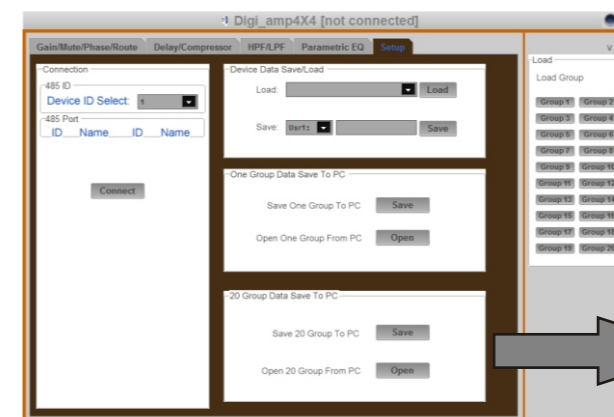
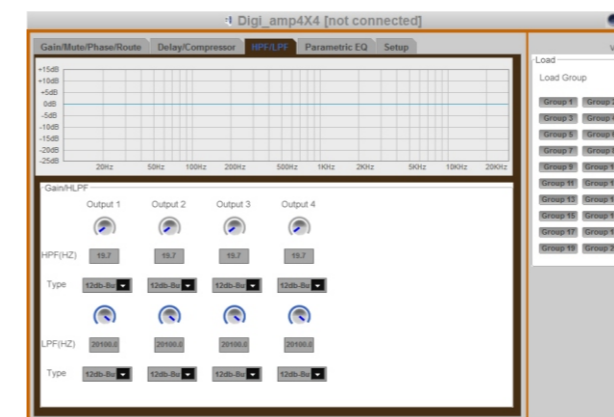
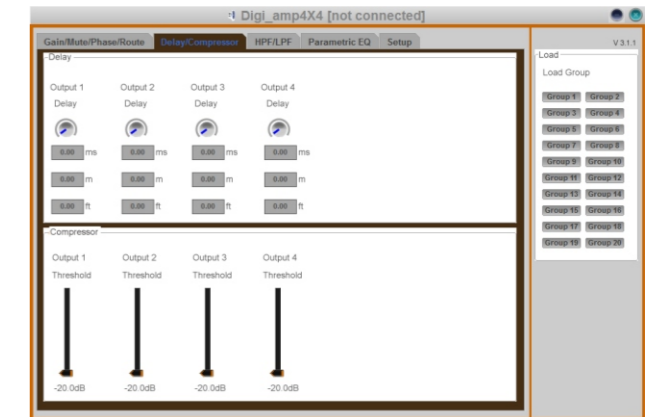

Output Mode Setup

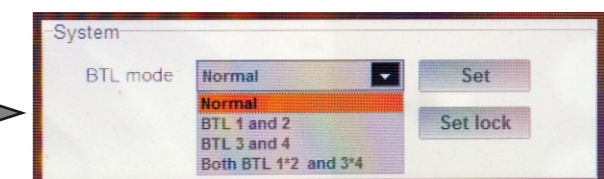

Audio input and output connections

Route

The signal input into any channel can be select output from any channel.

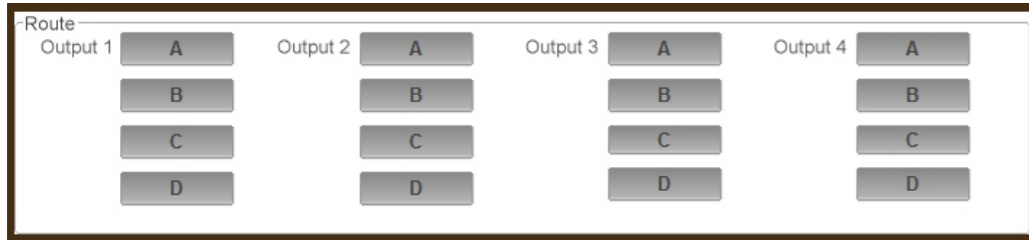

Stereo Mode

The signal input into channel 1 can be output from channel 1 only, similarly, the signal input into channel 2 can be output from channel 2 only. The many channels, one by one in order type pushes.

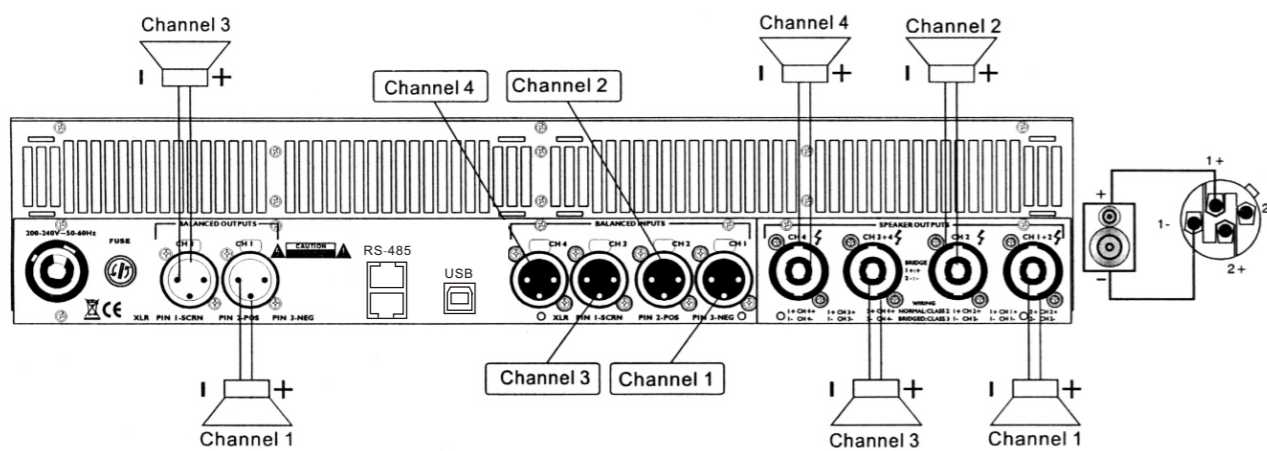

Bridge Mode

channel 1 and channel 2 are bridged,
channel 3 and channel 4 are bridged.

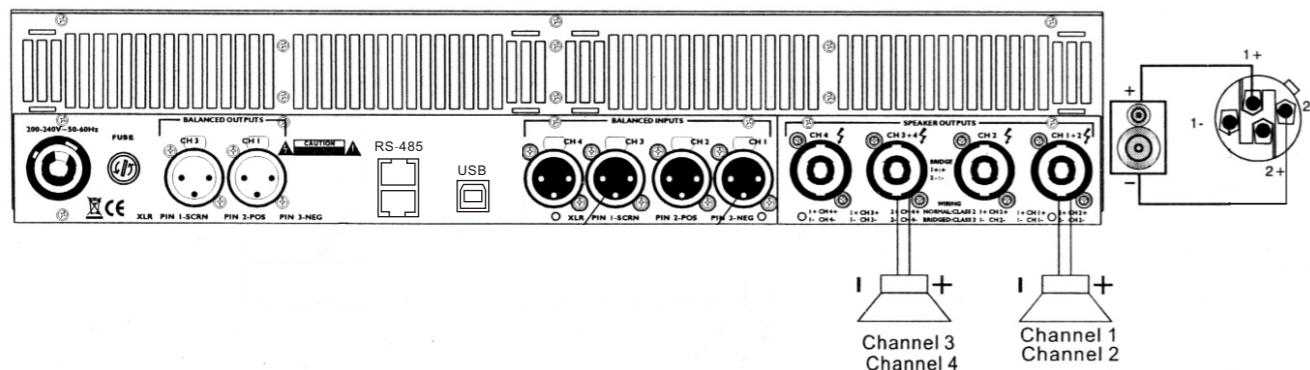

Control elements

Introduction of the front panel functions

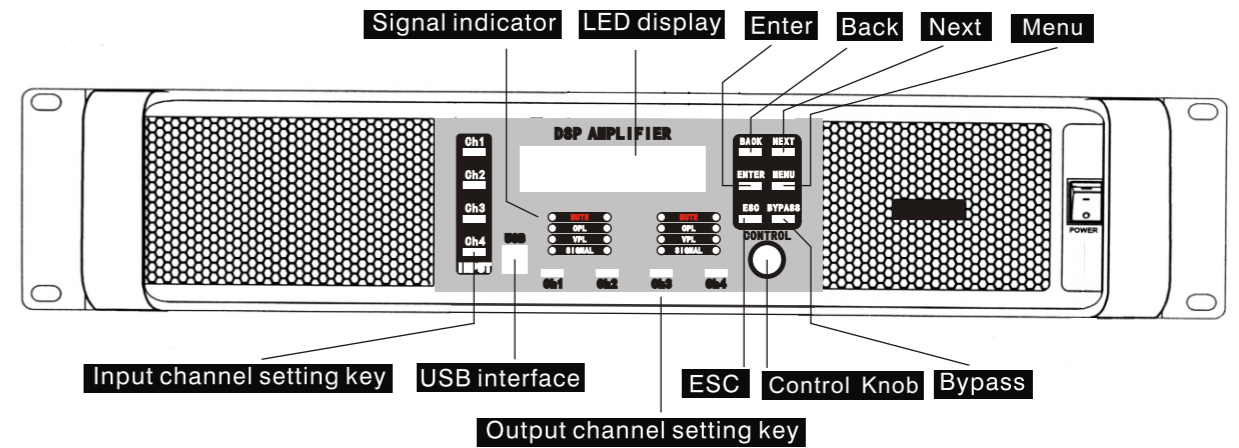

Signal indicator

- SIGNAL LED: Indicate output signal levels in normal operating range
- VPL LED: This indicator signals if the amplifier output is clipping or limiting.
- CPL LED: Low impedance/Short Circuit Detection Fault
- MUTE LED: MUTE-Audio protection under mute position.

LED display

Turn on the power supply, display light can display various parameters for use's convenience

Enter

Confirm the parameter you are setting or enter into operation menu

Back

To page up or move the cursor when edit

Next

To page down or move the cursor when edit

Menu

In standby state, press this key to enter the system setup program

Input channel setting key

Click this key to make current channel MUTE or Sound On.

Push this key 3 seconds to enter into this channel's setting mode

USB interface

Use a USB cable to connect the machine and PC

Output channel setting key

Click this key to make current channel MUTE or Sound On.

Push this key 3 seconds to enter into this channel's setting mode

ESC

Back to previous menu when click ESC in edit state or return to stand-by under other conditons

Control Knob

Set parameters in edit state

Bypass

Choose to open or close when editing EQ Adjusted parameter is not implemented under bypass condition

Rear panel features introduction

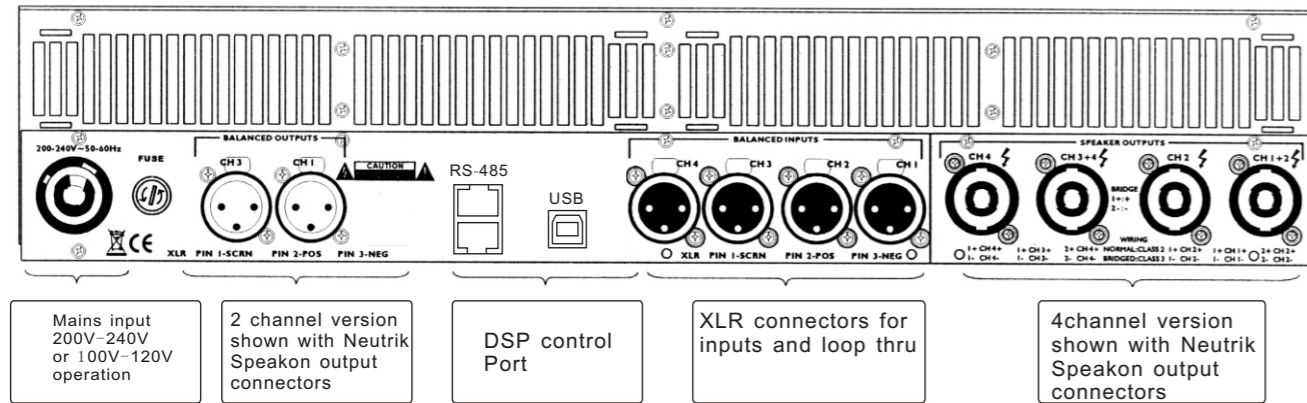

Rear panel features introduction

Speakon outputs-4-channel models

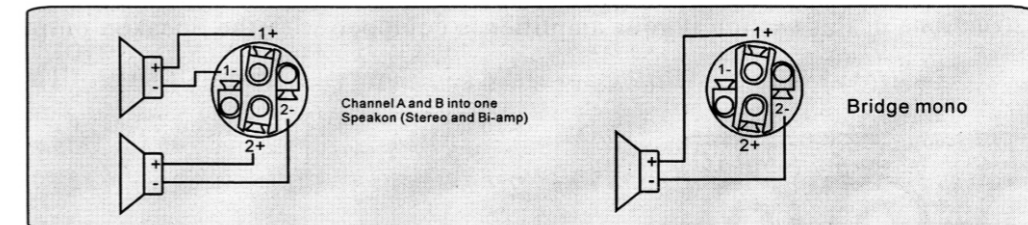

Four-channel amplifiers Additional connectors are provided for channel 3 and channel 4. Channel 3 functions as channel 1 above, and channel 4 as channel 2 above.

Input Connectors

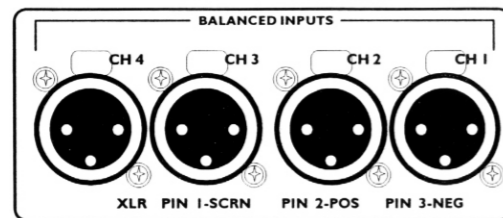

Audio inputs-4-channel models

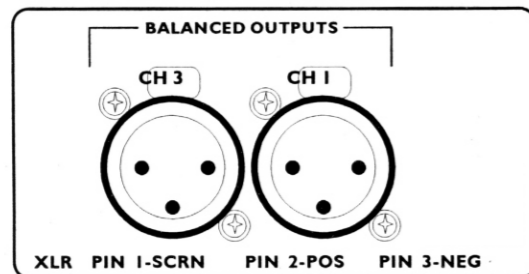

Audio link:

the signal input into channel 1 can be output from channel 1 only, similarly, the signal channel 3 is the same.

Output Connectors

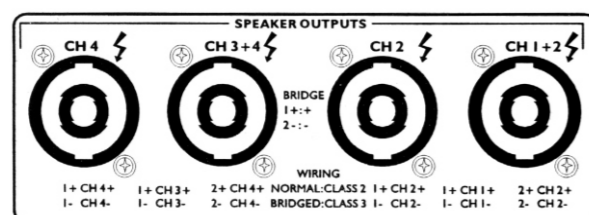

BALANCED INPUT CONNECTIONS

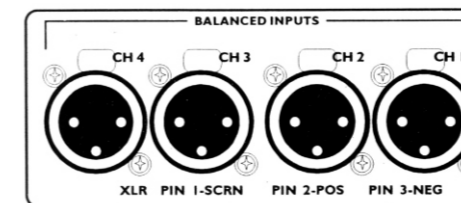

Audio input-4-channel models

The XLR input connectors are electronically balanced, and wired according to the IEC 268 standard (pin 2= hot). XLR input connectors should be wired follows:

- Pin 1 Ground/Shield
- Pin 2 Hot (+)
- Pin 3 Cold (-)

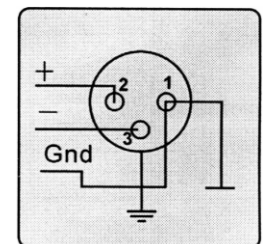

When linking the same source signal to several input channels, be aware that there is a limit to the number of channels an output source can "drive". A typical output source (e.g. a DSP crossover unit) can drive up to four amplifier channels before external line-drivers might be required to buffer the signal.

Unbalanced Input connections

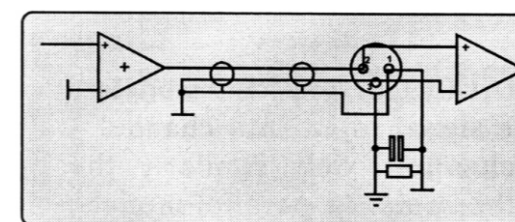

To connect an input to an unbalanced source, it is possible to connect pins 1 and 3 in the XLR plug at the amplifier end of the cable. However, a better method is to connect pin 3 to the shield at the source end of the cable, as this usually results in better hum and noise rejection. Balanced input connections are recommended whenever possible